



HANSON RIVET

& SUPPLY CO.

13241 Weidner Street
Pacoima, CA 91331

Phone: 818-485-0500

FAX: 818-485-0540

Outside CA: 1-800-RRRIVET

www.hansonrivet.com



GBP743C AIR-HYDRAULIC TOOL



GBP743C

Stroke - .900"

Hand held weight - 6.25 lbs.

Entire tool weight - 6.25 lbs

Pull load - 4,200

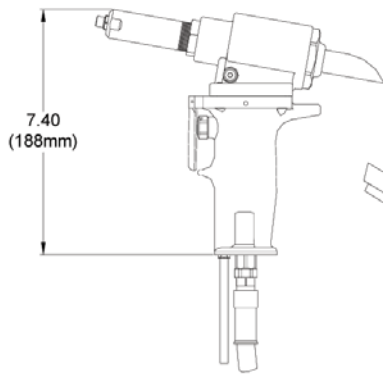
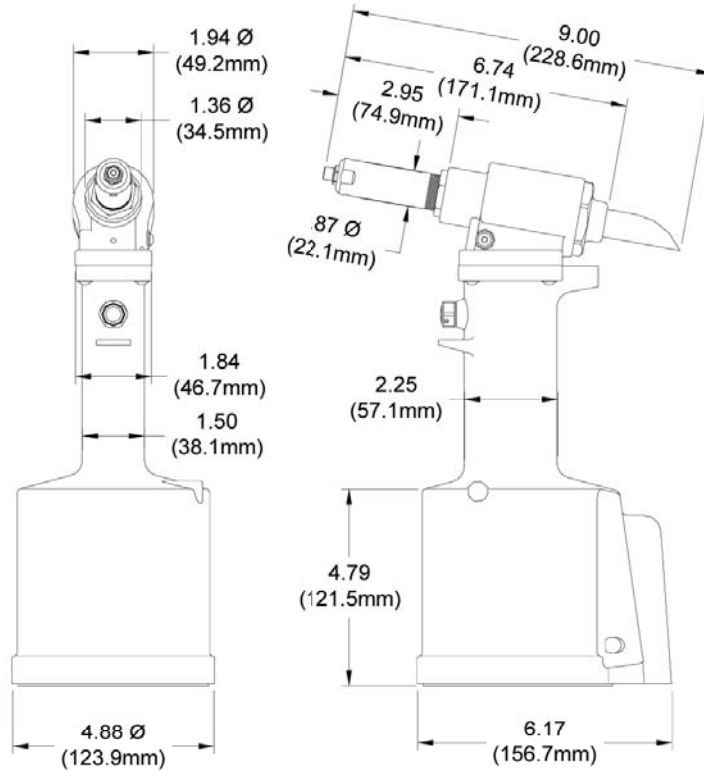

GBP743CSH

Stroke - .650"

Hand held weight - 2.25 lbs.

Entire tool weight - 7.25 lbs

Pull load - 4,200

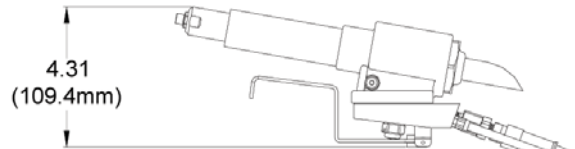
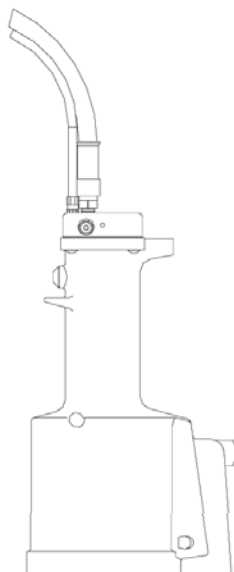

GBP743CSR

Stroke - .900"

Hand held weight - 1.75 lbs.

Entire tool weight - 6.75 lbs

Pull load - 4,200

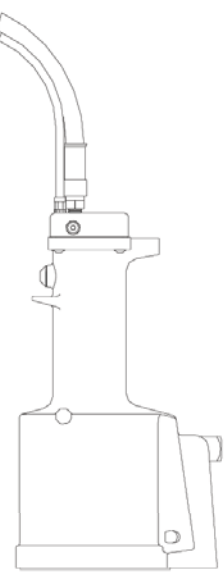



HANSON RIVET

& SUPPLY CO.

13241 Weidner Street
Pacoima, CA 91331

Phone: 818-485-0500

FAX: 818-485-0540

Outside CA: 1-800-RRRIVET

www.hansonrivet.com



GBP743C SELECTION CHART



GBP743C SERIES SELECTION CHART

RIVET	DIA.	NOSE ASSEMBLY	NOSE TIP	JAW	FOLLOWER	DESIGNATION
AVEX (1624 PROTRUDINGHEAD)	3/16	AV6-743A-24 1	10141	30849	40871	AV6
AVEX (1624 COUNTERSUNKHEAD)	3/16	6C-743A-24 1	10141-1	30849	40871	6C
BULB-TITE (STRUCTURAL RIVET)	1/4	BT08-743A-24 1	10391	30849	40871	BT08
KLAMPTITE (STRUCTURAL) RIVET	3/16	6KT-743A-24 1	10263	30849	40871	6KT
	1/4	8KT-743A-24 1	10262	30849	40871	8KT
MACHINE SCREW RIVET	5MM	MS5M-743A-24 1	10332	30849	40871	5MM
MONOBOLT RIVET	3/16	MB06-734A-20 2,3	10210	36801	48808	MB06
	1/4	MB08-734-20 2,3	10213	30833	48808	MB08
OPEN END CLOSED END NAIL RIVET	3/32	3N-743-20 2	10201	30537	40307	3N
	1/8	4N-743-20 2	10202	30537	40307	4N
	5/32	5N-743-20 2	10203	30537	40605	5N
	3/16	6N-743A-24 1	10204	30849	40871	6N
PLASTIC SPLIT RIVET	1/4	8N-743A-24 1	10211	30849	40871	8N
	3/32	3P-743-20 1	10247-1	30537	40307	3P
	1/8	4P-743-20 1	10202-4	30537	40307	4P
	5/32	5P-743-20 1	10203-2	30537	40605	5P
T RIVET	3/16	6P-743A-24 1	10167	30849	40871	6P
	1/4	8P-743A-24 1	10166	30849	40871	8P
TLR RIVET	3/16	6T-743A-24 1	10209	30849	40871	6T
	1/4	8T-743A-24 1	10286	30849	40871	8T
	1/4	8TLR-743A-24 1	10246	30849	40871	8TLR

SELECTION CHART FOR PROTRUDING HEAD ONLY

RIVET	DIA.	NOSE ASSEMBLY	NOSE TIP	JAW	FOLLOWER	DESIGNATION
SERRATED STEM	3/16	PH6-734A-20 2,3	10248	36801	48808	PH6
STRUCTURAL RIVET	1/4	PH8-734-20 2,3	10205	30833	48808	PH8

- 1) YOU CAN CHANGE THE 743A NOSE ASSEMBLY (INCLUDED WITH TOOL) TO INSTALL OTHER FASTENERS BY PURCHASING NOSE TIP SHOWN AND USING APPROPRIATE FOLLOWER SHOWN.
- 2) NOSE ASSEMBLIES WITH A 743 AND 734 DESIGNATION, I.E. 5N-743-20, MUST BE ORDERED AS COMPLETE NOSE ASSEMBLY.
- 3) NOSE ASSEMBLIES WITH A 734 DESIGNATION, I.E. PH6-734-20, ARE FOR SERRATED STEM RIVETS ONLY. IF YOU ARE PULLING BOTH SMOOTH AND SERRATED STEM RIVETS YOU MUST ORDER THE NOSE ASSEMBLY WITH A 743 DESIGNATION, I.E. MGL06-743A-24.

NOTE: THE LAST 2 DIGITS OF THE NOSE ASSEMBLY REPRESENTS THE LENGTH THE NOSE EXTENDS FROM THE TOOL. I.E. -20 = 2.0 INCHES

DESCRIPTION

The GBP743C series are pneumatic-hydraulic tools designed specifically for the efficient installation of a wide range of blind rivets. They can be operated in any position with one hand. They have a rated pull load of 4200 pounds with 90 psi air pressure at the air inlet.

The GBP743CSH and GBP743CSR riveters offer a unique "split" system providing the operator with an ergonomic tool with reduced hand held weight, as shown below.

The GBP743C series riveters operate on a wide range of air pressure, with 90 to 100 psi providing the maximum efficiency. At 90 lbs air pressure, the GBP743C series does not exceed 85 db (A) and consumes 3 cfm at 20 cycles a minute.

The GBP743C series riveters are furnished with nose assembly 8N-743A-24 and spare nose tip 10204 to convert to 6N-743A-24.

OPTIONS

The GBP743C series riveters may be ordered with a vacuum system.

We offer two varieties (see below)

Order GBP743C series riveters with the proper rivet specification by adding the appropriate suffix (see selection chart)

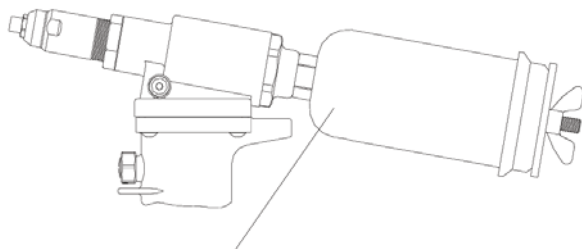

"V" DESIGNATION = PINTAIL COLLECTOR BOTTLE

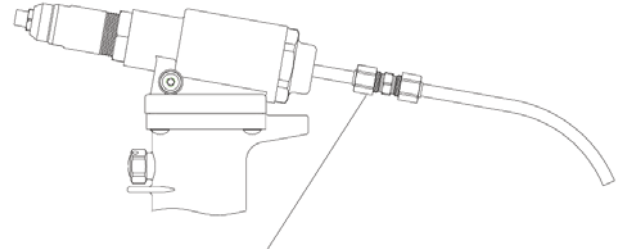

"VT" DESIGNATION = PINTAIL EVACUATION TUBE

HOW TO ORDER GBP743 SERIES TOOLS

